

Linear

FLO Lume Fixture Guide

KKDÖ

Indoor/Outdoor | Suspended | Output up to 1105lm/m (337lm/ft)



IP68

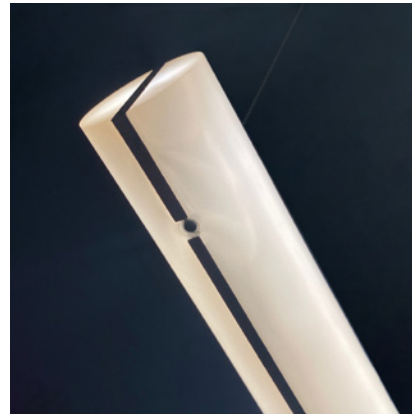
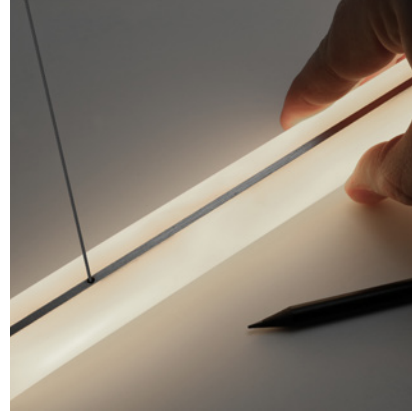

Key applications

- ✓ Bathrooms
- ✓ Down lighting
- ✓ Ceiling pendant
- ✓ Interior/Exterior
- ✓ Direct/Indirect lighting
- ✓ Wet area

Key features

- ✓ Custom lengths
- ✓ Extensive CCT range
- ✓ Constant voltage (CV)
- ✓ High impact resistance
- ✓ Decorative
- ✓ Illuminated ends
- ✓ Diffusion: Homogenous
- ✓ IP68

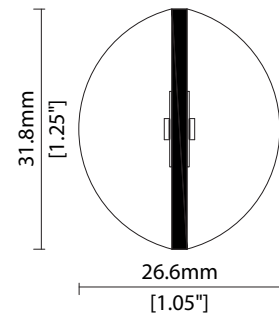

MOUNTING METHODS



KKSW-10 Suspension kit

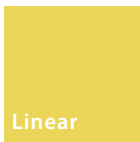

FLO Lume

Specification sheet



Dimensions	H28/W31.8/L129-4004mm (1.10/1.25/5.079-157.64in)
PCB Cut-point	62.5mm increment/4000mm max (2.46in increment/157.48in max)
LED Pitch	10.4mm - 192LED/m (0.41in - 58LED/ft)
Chip	s-line k-line
Cover/Optics	Diffused resin (130deg x2)
CCT	s-line: 1900K/2100K/2300K/2500K/2700K/3000K/3500K/4000K/5000K k-line: 1900K/2100K/2300K/2500K/2700K/3000K/3500K/4000K/5000K
LED binning	s-line: 2-step MacAdam ellipse k-line: 3-step MacAdam ellipse
CRI	87
Lifetime	50,000 hours @ 25°C (50,000 hours @ 77°F)
Operating temp	T _a = -25 to 40°C (T _c max = 75°C) T _a = -13 to 104°F (T _c max = 167°F)
IP Rating	IP68
Finish	Custom alabaster marble effect resin/Anodized aluminium
Mounting	Suspension kit
Power feed	Hardwire tail
Control	0-10V/1-10V/DMX/DALI



LED Grading Key

Exclusive Grade

s-line*
2-step CCT range

*KKDC tuned
CCT range

Base Grade

k-line
3-step commercial range
Energy Star CCTs

Power consumption	Supply voltage	Supply current
36W/m (10.97W/ft)	24V DC	1.5A/m (0.46A/ft)

Performance Data (3000K)

	R1	R2	R3	R4	R5	R6	R7	R8	R9	R10	R11	R12	R13	R14
s-line	87	90	93	88	85	86	94	80	49	77	87	64	87	96

	Diffused	CRI	R9	Rf	Rg
s-line	1105lm/m (337lm/ft) 30.7lm/W	87	49	-	-

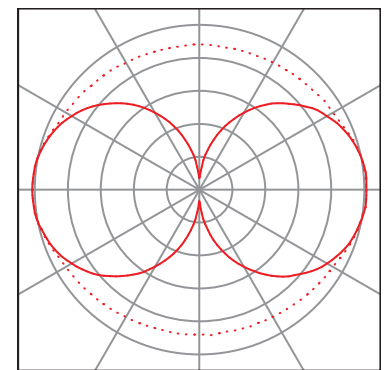
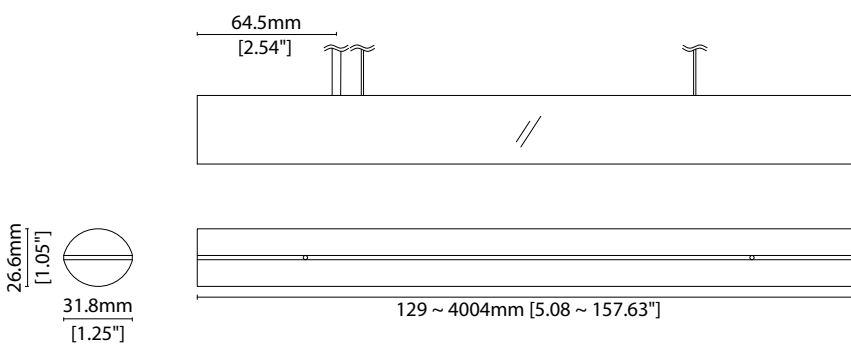

— C0 / C180 cd / 1000 lm - - - C90 / C270

Data derived from independent UKAS / IESNA LM-79-08 accredited testing of production samples.

FIXTURE

Model	Grade ¹	LED	Colour (CCT)	Length Availability ²	IP	Cable Length	Power Feed ³	Input		
FLO Lume	FL	s k	FX18 918	1900K 19 2100K 21 2300K 23 2500K 25 2700K 27 3000K 30 3500K 35 4000K 40 5000K 50	m i	129-4004mm 62.5mm increments 5,079-157,64in 2,46in increments (Specify length code OR total run length)	IP68 68	3000mm (118.11in) 3000	Suspension Single no sheath tail ⁴ S00H	DC 24V g

¹ Refer to **LED Grading Key** on **Specification sheet** page

² Refer to **Length Availability List** or enter total run length instead of length code

³ Refer to **Power Feed Options** on **Options** pages

⁴ Transparent suspension wire

Code Example:

FL	-	s	-	918	-	35	-	m	-	504	-	68	-	3000	-	S00H	-	g
FLO Lume		s		FX18		3500K		504mm		IP68		3000mm (118.11in)		Suspension Single no sheath tail		DC 24V		

ACCESSORIES

Mounting Accessories

KKSW-10 Suspension kit

* Refer to **Mounting accessories** on **Accessories** pages

PSU/Driver

0-10V/1-10V/DALI/DMX

* Refer to **Driver/PSU Options** page for details or provide requirement and KKDC to offer the suitable option

FLO Lume

Length Availability List



Length Code		Fixture Length ¹		LED Strip ²		End Cap Dimension		Wattage (W)	Output (lm)
Metric	Imperial(US)	Metric	Imperial(US)	Metric	Imperial(US)	Metric	Imperial(US)		3000K (Test Data)
m0129	i0005	129mm	5.08in	125mm	4.92in	N/A	N/A	4.50	144
m0192	i0008	192mm	7.54in	188mm	7.38in	N/A	N/A	6.75	216
m0254	i0010	254mm	10.00in	250mm	9.84in	N/A	N/A	9.00	288
m0317	i0012	317mm	12.46in	313mm	12.30in	N/A	N/A	11.25	360
m0379	i0015	379mm	14.92in	375mm	14.76in	N/A	N/A	13.50	432
m0442	i0017	442mm	17.38in	438mm	17.22in	N/A	N/A	15.75	504
m0504	i0020	504mm	19.84in	500mm	19.69in	N/A	N/A	18.00	576
m0567	i0022	567mm	22.30in	563mm	22.15in	N/A	N/A	20.25	648
m0629	i0025	629mm	24.76in	625mm	24.61in	N/A	N/A	22.50	720
m0692	i0027	692mm	27.22in	688mm	27.07in	N/A	N/A	24.75	792
m0754	i0030	754mm	29.69in	750mm	29.53in	N/A	N/A	27.00	864
m0817	i0032	817mm	32.15in	813mm	31.99in	N/A	N/A	29.25	936
m0879	i0035	879mm	34.61in	875mm	34.45in	N/A	N/A	31.50	1008
m0942	i0037	942mm	37.07in	938mm	36.91in	N/A	N/A	33.75	1080
m1004	i0040	1004mm	39.53in	1000mm	39.37in	N/A	N/A	36.00	1152
m1067	i0042	1067mm	41.99in	1063mm	41.83in	N/A	N/A	38.25	1224
m1129	i0044	1129mm	44.45in	1125mm	44.29in	N/A	N/A	40.50	1296
m1192	i0047	1192mm	46.91in	1188mm	46.75in	N/A	N/A	42.75	1368
m1254	i0049	1254mm	49.37in	1250mm	49.21in	N/A	N/A	45.00	1440
m1317	i0052	1317mm	51.83in	1313mm	51.67in	N/A	N/A	47.25	1512
m1379	i0054	1379mm	54.29in	1375mm	54.13in	N/A	N/A	49.50	1584
m1442	i0057	1442mm	56.75in	1438mm	56.59in	N/A	N/A	51.75	1656
m1504	i0059	1504mm	59.21in	1500mm	59.06in	N/A	N/A	54.00	1728
m1567	i0062	1567mm	61.67in	1563mm	61.52in	N/A	N/A	56.25	1800
m1629	i0064	1629mm	64.13in	1625mm	63.98in	N/A	N/A	58.50	1872
m1692	i0067	1692mm	66.59in	1688mm	66.44in	N/A	N/A	60.75	1944
m1754	i0069	1754mm	69.06in	1750mm	68.90in	N/A	N/A	63.00	2016
m1817	i0072	1817mm	71.52in	1813mm	71.36in	N/A	N/A	65.25	2088
m1879	i0074	1879mm	73.98in	1875mm	73.82in	N/A	N/A	67.50	2160
m1942	i0076	1942mm	76.44in	1938mm	76.28in	N/A	N/A	69.75	2232
m2004	i0079	2004mm	78.90in	2000mm	78.74in	N/A	N/A	72.00	2304
m2067	i0081	2067mm	81.36in	2063mm	81.20in	N/A	N/A	74.25	2376
m2129	i0084	2129mm	83.82in	2125mm	83.66in	N/A	N/A	76.50	2448
m2192	i0086	2192mm	86.28in	2188mm	86.12in	N/A	N/A	78.75	2520
m2254	i0089	2254mm	88.74in	2250mm	88.58in	N/A	N/A	81.00	2592
m2317	i0091	2317mm	91.20in	2313mm	91.04in	N/A	N/A	83.25	2664
m2379	i0094	2379mm	93.66in	2375mm	93.50in	N/A	N/A	85.50	2736
m2442	i0096	2442mm	96.12in	2438mm	95.96in	N/A	N/A	87.75	2808
m2504	i099	2504mm	98.58in	2500mm	98.43in	N/A	N/A	90.00	2880
m2567	i0101	2567mm	101.04in	2563mm	100.89in	N/A	N/A	92.25	2952
m2629	i0104	2629mm	103.50in	2625mm	103.35in	N/A	N/A	94.50	3024
m2692	i0106	2692mm	105.96in	2688mm	105.81in	N/A	N/A	96.75	3096
m2754	i0108	2754mm	108.43in	2750mm	108.27in	N/A	N/A	99.00	3168

FLO Lume

Length Availability List



Length Code		Fixture Length ¹		LED Strip ²		End Cap Dimension		Wattage (W)	Output (lm)
Metric	Imperial(US)	Metric	Imperial(US)	Metric	Imperial(US)	Metric	Imperial(US)		3000K (Test Data)
m2817	i0111	2817mm	110.89in	2813mm	110.73in	N/A	N/A	101.25	3240
m2879	i0113	2879mm	113.35in	2875mm	113.19in	N/A	N/A	103.50	3312
m2942	i0116	2942mm	115.81in	2938mm	115.65in	N/A	N/A	105.75	3384
m3004	i0118	3004mm	118.27in	3000mm	118.11in	N/A	N/A	108.00	3456
m3067	i0121	3067mm	120.73in	3063mm	120.57in	N/A	N/A	110.25	3528
m3129	i0123	3129mm	123.19in	3125mm	123.03in	N/A	N/A	112.50	3600
m3192	i0126	3192mm	125.65in	3188mm	125.49in	N/A	N/A	114.75	3672
m3254	i0128	3254mm	128.11in	3250mm	127.95in	N/A	N/A	117.00	3744
m3317	i0131	3317mm	130.57in	3313mm	130.41in	N/A	N/A	119.25	3816
m3379	i0133	3379mm	133.03in	3375mm	132.87in	N/A	N/A	121.50	3888
m3442	i0135	3442mm	135.49in	3438mm	135.33in	N/A	N/A	123.75	3960
m3504	i0138	3504mm	137.95in	3500mm	137.80in	N/A	N/A	126.00	4032
m3567	i0140	3567mm	140.41in	3563mm	140.26in	N/A	N/A	128.25	4104
m3629	i0143	3629mm	142.87in	3625mm	142.72in	N/A	N/A	130.50	4176
m3692	i0145	3692mm	145.33in	3688mm	145.18in	N/A	N/A	132.75	4248
m3754	i0148	3754mm	147.80in	3750mm	147.64in	N/A	N/A	135.00	4320
m3817	i0150	3817mm	150.26in	3813mm	150.10in	N/A	N/A	137.25	4392
m3879	i0153	3879mm	152.72in	3875mm	152.56in	N/A	N/A	139.50	4464
m3942	i0155	3942mm	155.18in	3938mm	155.02in	N/A	N/A	141.75	4536
m4004	i0158	4004mm	157.64in	4000mm	157.48in	N/A	N/A	144.00	4608

¹ Actual total overall length of light fixture

² Actual length of PCB strip

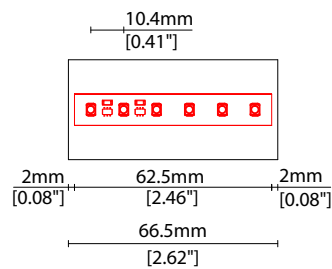

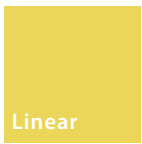

FLO Lume Options



POWER FEED OPTIONS

* Options are an integral part of the fixture ordering codes. Please refer to **Code Table** pages.

3000 S00H 3000mm (118.11") Suspension single no sheath tail

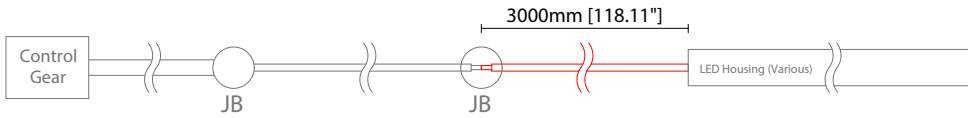

Key

Control Gear Power supply, sub-controllers & control systems
JB Junction box / cable connection

MOUNTING ACCESSORIES

Note: Accessories are to be ordered separately with corresponding code shown below.

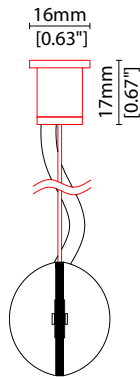

KKS-10

Suspension Mounting Kit
S/Steel finish

L16/W16/H3000mm (MAX drop)
(L0.63/W0.63/H118.11in (MAX drop))

KKDC CONTROL



IP20
Plastic housing
L170/W59/H29mm
(L6.69/W2.32/H1.14in)

KKDM-06 1-10V

visDIM dimmable sub-controller
(4 x 8A max @ 12-36V)



IP20
Plastic housing
L170/W53.4/H28mm
(L6.69/W2.10/H1.10in)

KKSC-05 DMX

visDIM dimmable sub-controller
(4 x 5A max @ 12-36V)



IP20
Plastic housing
L170/W59/H29mm
(L6.69/W2.32/H1.14in)

KKDL-02 DALI

visDIM dimmable sub-controller
(4 x 8A max @ 12-36V)



IP20
Plastic housing
L166/W53.4/H23mm
(L6.54/W2.10/H0.91in)

KKDL-03 DALI

visDIM dimmable sub-controller
(4 x 5A max @ 12-36V)

AVAILABLE PSU OPTIONS

Control Mode	PSU (Order Code)	Input Voltage AC	Output Voltage DC	Rated Output Current	Rated Power	Dim %	IP Rating
Switched	CEN-60-24	90-295V	24V	2.5A	60W	-	IP67
	HLG-60H-24	90-305V	24V	2.5A	60W	-	IP67
	HLG-100H-24	90-305V	24V	4.0A	100W	-	IP67
	HLG-150H-24	90-305V	24V	6.3A	150W	-	IP67
	HLG-240H-24	90-305V	24V	10A	240W	-	IP67
0-10V (1-10V)	PWM-40-24	90-305V	24V	1.67A	40W	100-0.15 (100-10)	IP67
	PWM-60-24	90-305V	24V	2.5A	60W	100-0.15 (100-10)	IP67
	PWM-90-24	90-305V	24V	3.67A	90W	100-0.15 (100-10)	IP67
	PWM-120-24	90-305V	24V	5.0A	120W	100-0.15 (100-10)	IP67
DALI	LIN100A1	120-277V	24V	1A per channel	100W	100-0.1	IP66/IP40
DMX RGB	LIN100A1	120-277V	24V	1.33A per channel	100W	100-0.1	IP66/IP40
DMX RGBW	LIN100A1	120-277A	24V	1A per channel	100W	100-0.1	IP66/IP40

Flicker Free Options - Combination of PSU+ sub-controller

Control Mode	PSU (Order Code)	Sub-controller (Order Code)	Input Voltage AC	Output Voltage DC	Rated Output Current	Rated Power	Dim %	IP Rating PSU/ Sub-controller
0-10V or 1-10V	CEN-60-24	KKDM-06	90-295V	24V	2.5A	60W	100-0.9	IP67/IP20
	HLG-60H-24	KKDM-06	90-295V	24V	2.5A	60W	100-0.9	IP67/IP20
	HLG-100H-24	KKDM-06	90-295V	24V	4.0A	100W	100-0.9	IP67/IP20
	HLG-150H-24	KKDM-06	90-295V	24V	6.3A	150W	100-0.9	IP67/IP20
	HLG-240H-24	KKDM-06	90-295V	24V	10.0A	240W	100-0.9	IP67/IP20
DALI	CEN-60-24	KKDL-02/03	90-295V	24V	2.5A	60W	100-0.1	IP67/IP20
	HLG-60H-24	KKDL-02/03	90-305V	24V	2.5A	60W	100-0.1	IP67/IP20
	HLG-100H-24	KKDL-02/03	90-305V	24V	4.0A	100W	100-0.1	IP67/IP20
	HLG-150H-24	KKDL-02/03	90-305V	24V	6.3A	150W	100-0.1	IP67/IP20
	HLG-240H-24	KKDL-02/03	90-305V	24V	10.0A	240W	100-0.1	IP67/IP20
DMX RGB	CEN-60-24	KKSC-05	90-295V	24V	2.5A	60W	100-0.9	IP67/IP20
	HLG-60H-24	KKSC-05	90-305V	24V	2.5A	60W	100-0.9	IP67/IP20
	HLG-100H-24	KKSC-05	90-305V	24V	4A	100W	100-0.9	IP67/IP20
	HLG-150H-24	KKSC-05	90-305V	24V	6.3A	150W	100-0.9	IP67/IP20
	HLG-240H-24	KKSC-05	90-305V	24V	10.0A	240W	100-0.9	IP67/IP20

¹ The items shown above cover the most frequently used specification but does not exhaust the possible options

² PSU and/or driver can be chosen from the table, or KKDC may recommend the best option upon receipt of the controls requirement and installation environment

³ Electrical shop drawing will include detailed information of PSU and relevant control drivers

⁴ Cut sheets are available on the controls section of www.kkdc.lighting or upon request